



**Assembly and Operating Instructions for
Outback® Omega 200, and Omega 250 Gas Barbecues**



Omega 200



Omega 250

Photographs are not to scale.
Specifications subject to change
without prior notice.



WARNING

- For outdoor use only.
- Read instructions before using the appliance. Failure to follow instructions could result in death, serious bodily injury, and/or property loss.
- Warning: accessible parts may be very hot. Keep young children away.
- Do not move the appliance during use.
- Turn off the gas supply at the gas bottle after use.
- Any modification of the appliance, misuse, or failure to follow the instructions may be dangerous and will invalidate your warranty. This does not affect your statutory rights.
- Retain these instructions for future reference.
- Leak test annually, and whenever the gas bottle is removed or replaced. Check the hose connections are tight and leak test each time you reconnect the gas bottle.

FOR YOUR SAFETY

If you smell gas:

1. Shut off gas to the appliance.
2. Extinguish any open flame.
3. Open barbecue lid or hood.
4. If odour continues, discontinue use and contact your local dealer.

FOR YOUR SAFETY

1. Do not store or use petrol or other flammable vapours or liquids in the vicinity of this or any other appliance.
2. A gas bottle not connected for use shall not be stored in the vicinity of this or any other appliance.

A. Parts List

Quantities vary according to model purchased. Specifications subject to change without prior notice. For more details on hardware, please see the corresponding Hardware Reference Diagram for your barbecue model.

	CODE	PART	QTY	OUTBACK® OMEGA RANGE	
				OMEGA 200	OMEGA 250
Body Assembly	A1	Lava Rock / Basket	1	✓	✓
	A2	Burner	1	✓+	✓+
	A3	Hood Handle	1	✓	✓
	A4	Hood	1	✓+	✓+
	A5	Body	1	✓+	✓+
	A6	Grease Cup Holder	1	✓+	✓+
	A7	Grease Cup	1	✓	✓
	A8	Cooking Grill	1	✓	✓
	A9	Upper Hinge Bracket	2	✓+	✓+
	A10	Lower Hinge Bracket	2	✓+	✓+
	A11	Main Electrode (with Gas Collector Box)	1	✓+	✓+
	A12	Warming Rack	1	✓	✓
	A13	Outback® Logo Badge	1	✓+	✓+
Upper Trolley	B1	Control Panel	1	✓+▲	✓+▲
	B2	Ignition Button	1	✓+▲	✓+▲
	B3	Knob	2	✓+	✓+
	B4	Arch Support	2	✓+	✓+
	B5	Hose/Regulator Assembly	1	✓+	✓+
	B6	Plastic Side Shelf	★	2	1
	B7	Side Burner Knob	1		✓+
	B8	Side Burner Grid	1		✓
	B9	Side Burner Shelf	1		✓
	B10	Side Burner	1		✓+
	B11	Side Burner Electrode	1		✓+
	B12	Side Burner Support Tray	1		✓+
	B13	Hinge Spindle	1	✓+	✓+
	B14	R Clip	1	✓+	✓+
	B15	Body Spacer	1	✓+	✓+
	B16	Control Panel Heat Shield	1	✓+	✓+
	B17	Valve Assembly	1	✓+	✓+
	B18	Rear Support	1	✓+	✓+
Lower Trolley	C1	Left Front Leg	1	✓	✓
	C2	Left Rear Leg	1	✓	✓
	C3	Short Axle	2	✓	✓
	C4	Wheel	2	✓	✓
	C5	Hubcap	2	✓	✓
	C6	Screen	1	✓	✓
	C7	Leg Endcap	2	✓+	✓+
	C8	Right Front Leg	1	✓	✓
	C9	Right Rear Leg	1	✓	✓
	C10	Bottom Shelf	1	✓	✓
Hardware	D1	M5x10 Bolt	2	✓+	✓+
	D2	M6x25 Bolt	4	✓	✓
	D3	M6x30 Bolt	4	✓	✓
	D4	M6x40 Bolt	8	✓	✓
	D5	M6x50 Bolt	4	✓	✓
	D6	Axle Clip	2	✓	✓
	D7	M6 Nut	20	✓	✓
	D8	Shelf Spacer	8	✓	✓
	D9	Shelf Washer	8	✓	✓

✚ Pre-Assembled Component

★ Quantity varies according to model purchased

▲ Appearance, size, and construction may differ according to model purchased

B1. Parts Diagram: Omega 200

Quantities vary according to model purchased. Specifications subject to change without prior notice. For more details on hardware, please see 'Hardware Reference Diagram: Omega 200.'

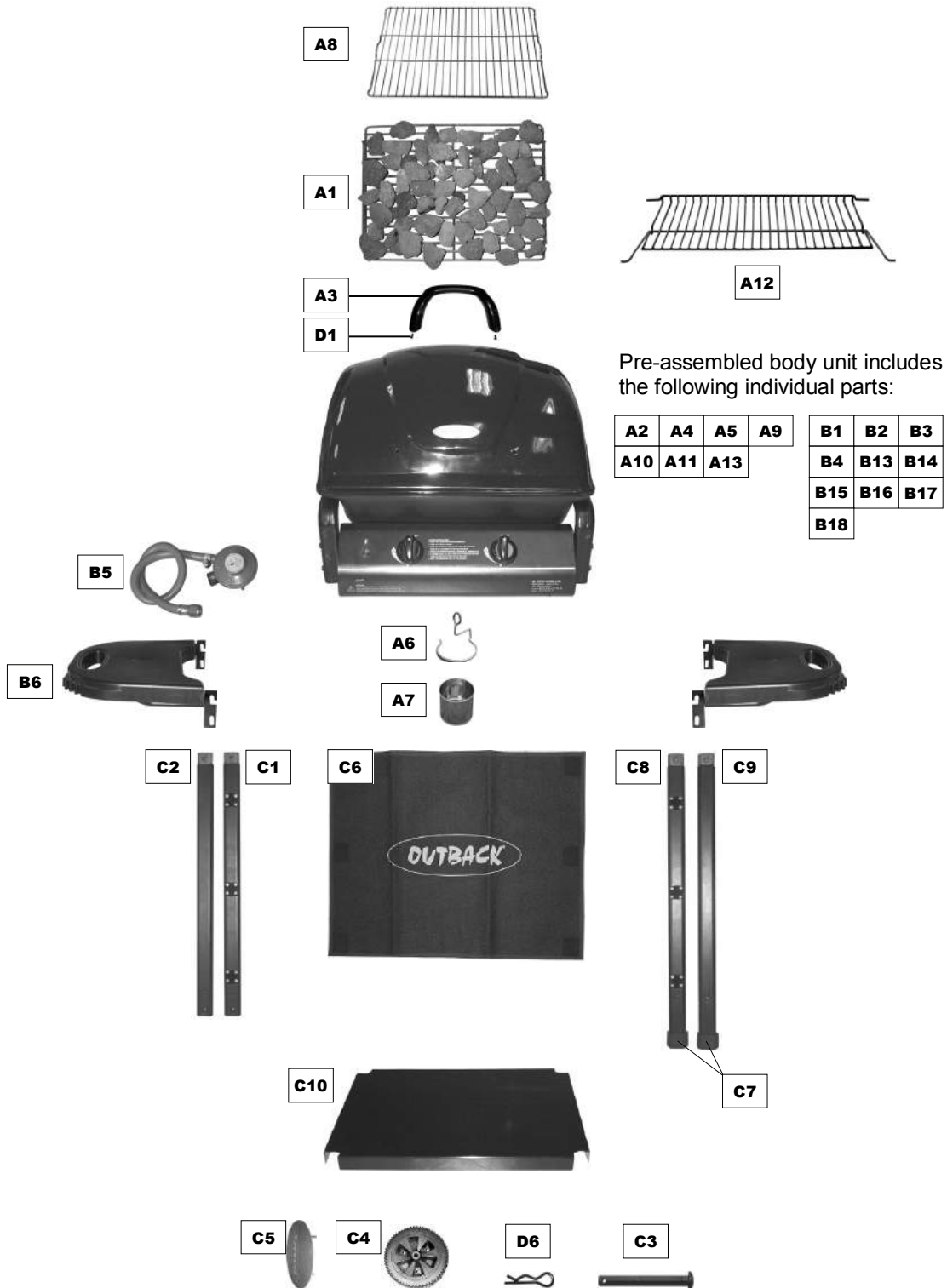

B2. Hardware Reference Diagram: Omega 200

Specifications subject to change without prior notice.

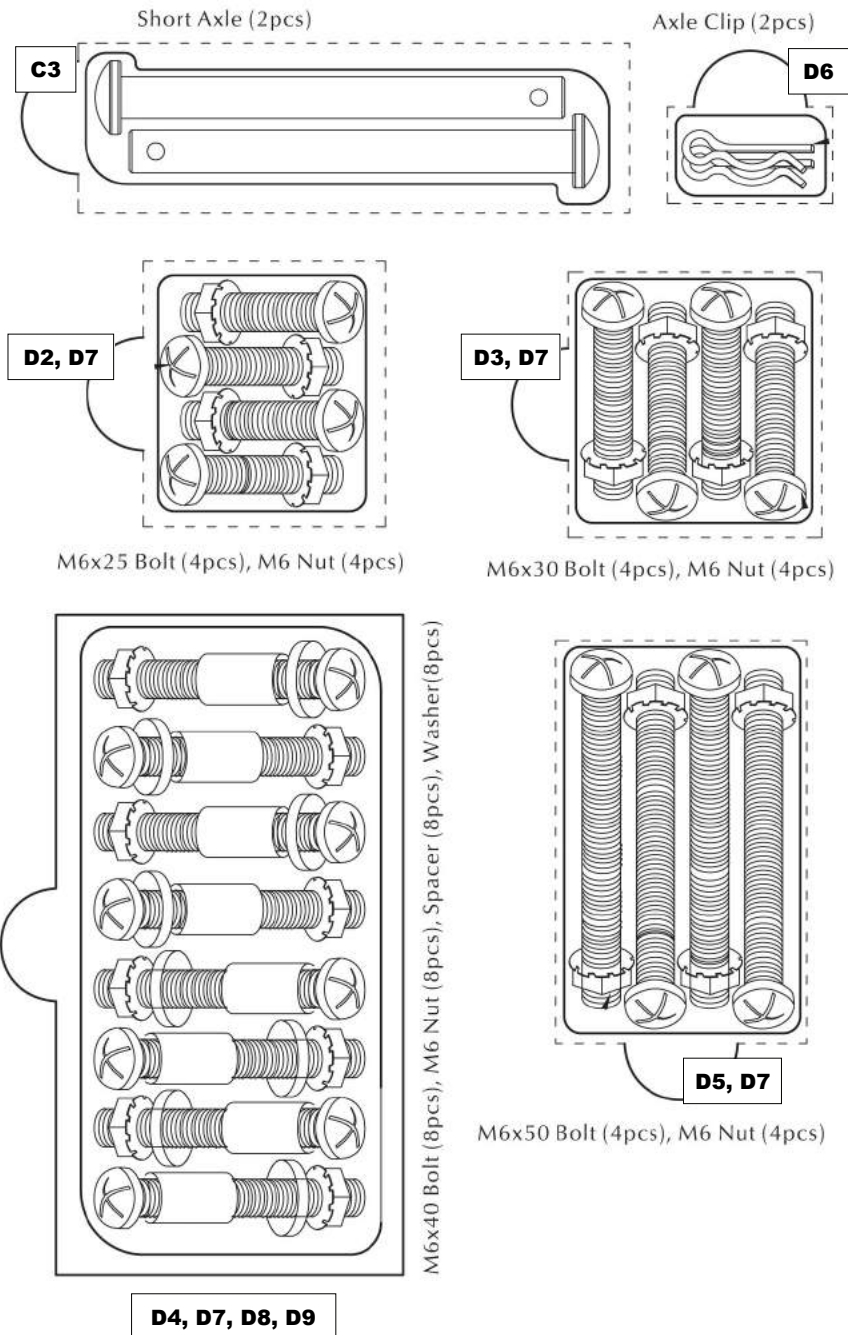

C1. Parts Diagram: Omega 250

Quantities vary according to model purchased. Specifications subject to change without prior notice. For more details on hardware, please see 'Hardware Reference Diagram: Omega 250.'

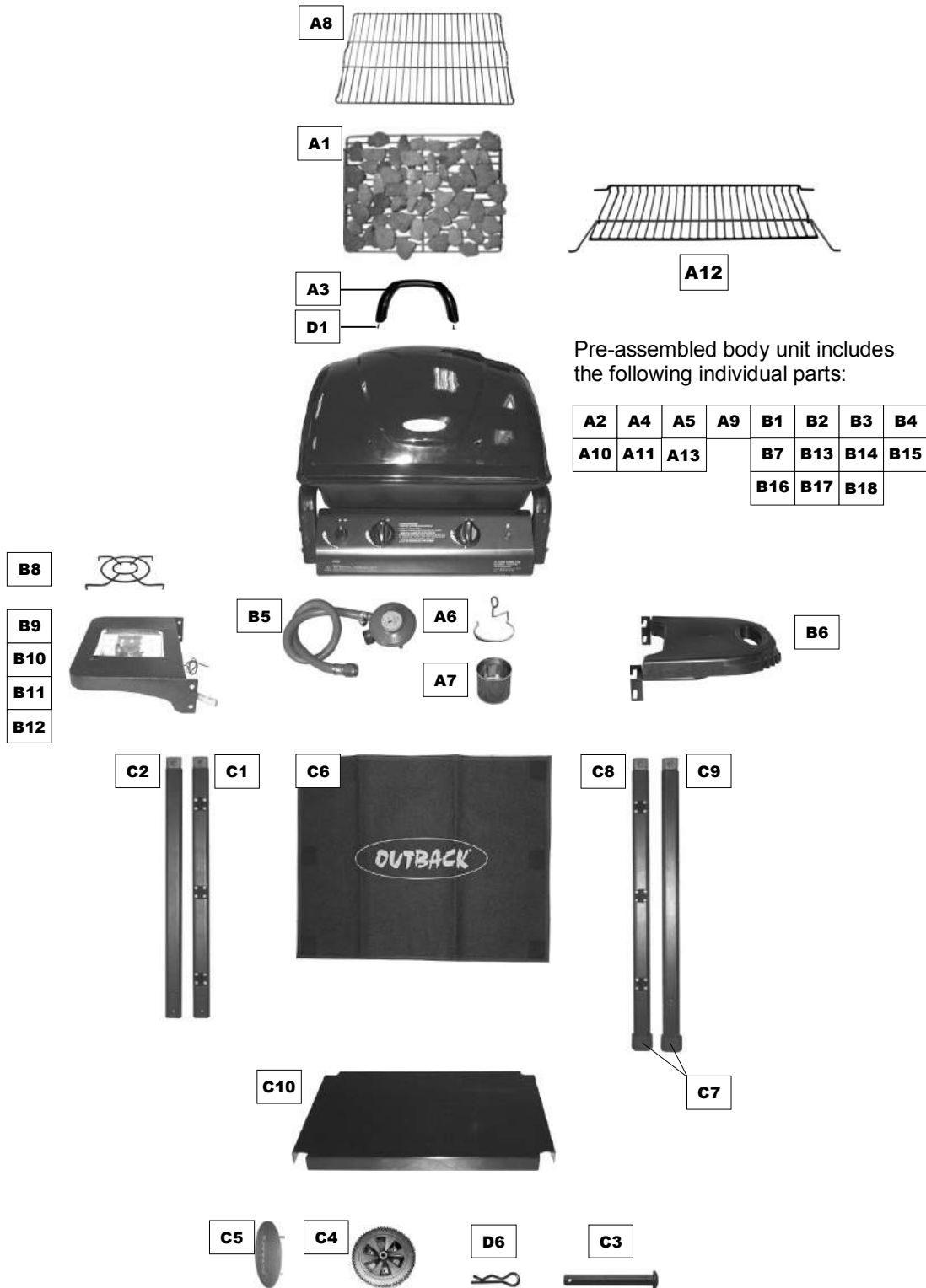

C2. Hardware Reference Diagram: Omega 250

Specifications subject to change without prior notice.

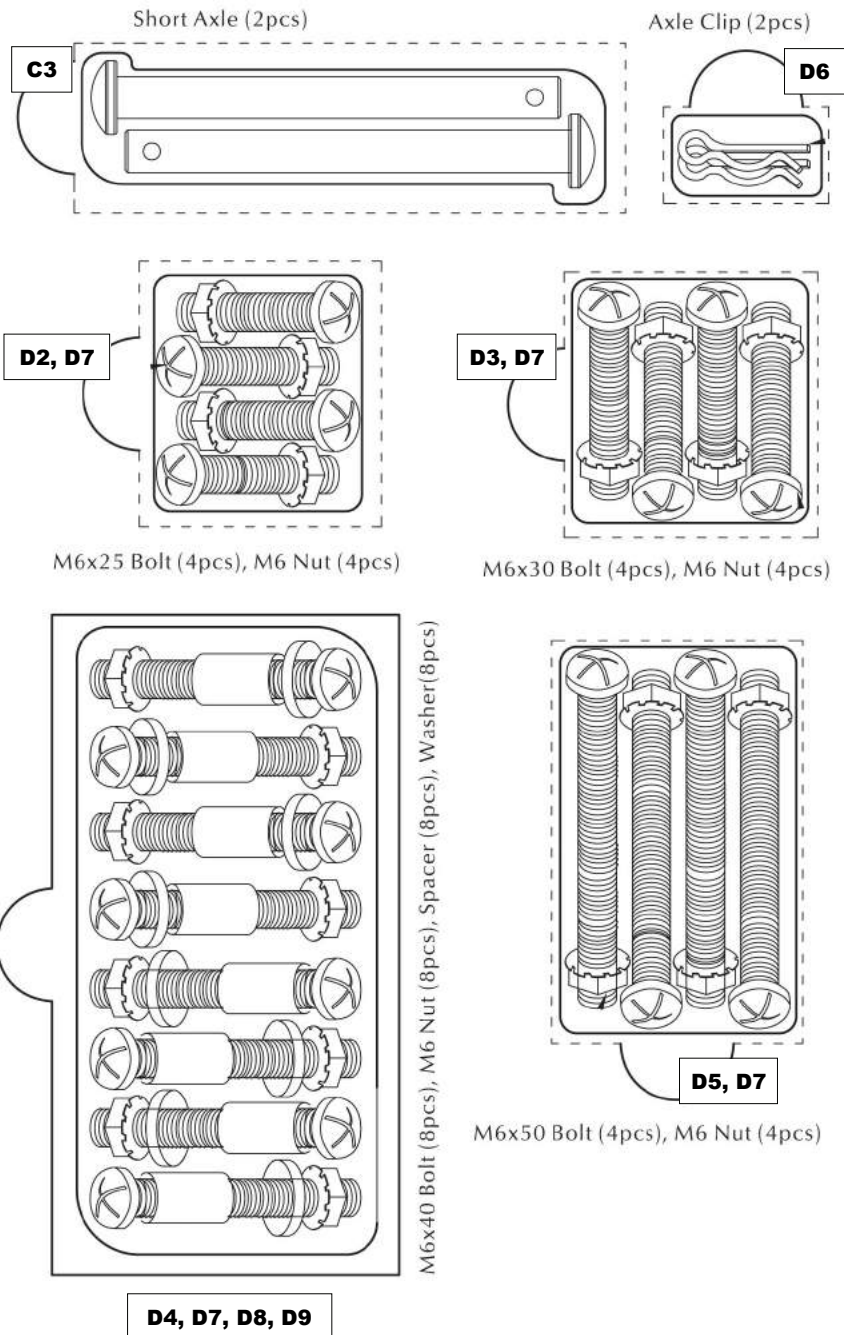

D. Assembly

IMPORTANT!

- **TOOLS NEEDED FOR ASSEMBLY:** Medium size flat blade or Phillips/Crosspoint screwdriver, adjustable spanner or metric spanner set.
- Remove any internal components or packaging from the barbecue body.
- Whilst every care is taken in the manufacture of this product, care must be taken during assembly in case sharp edges are present.
- **Please read the Important Information section carefully before assembly and use of your barbecue.**

1

✓ Omega 200

✓ Omega 250

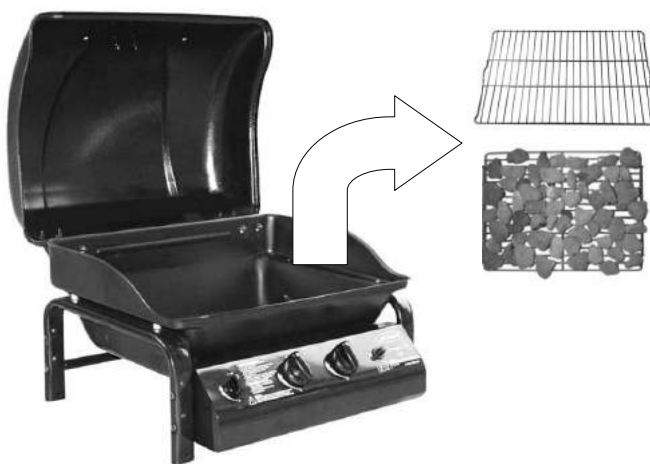

2

✓ Omega 200

✓ Omega 250

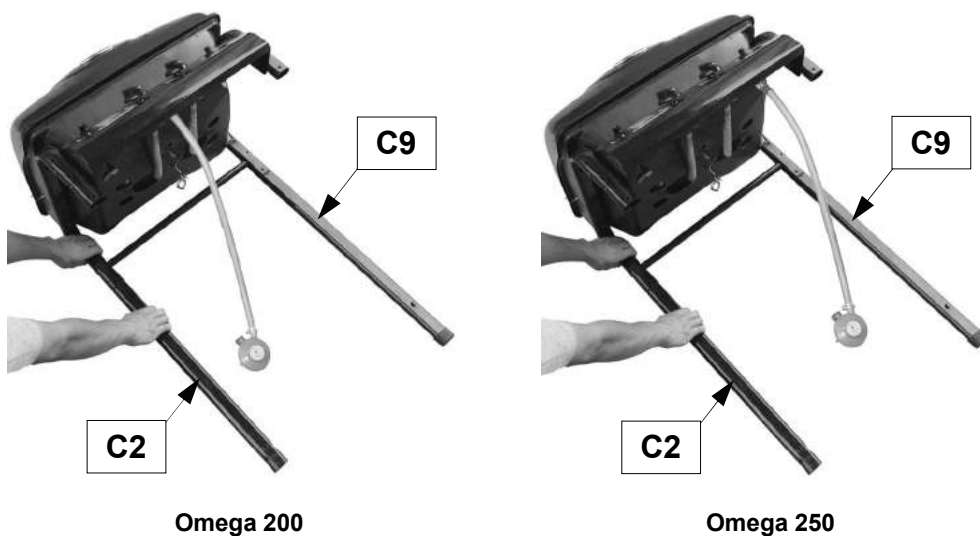

Warning: Care must be taken to ensure hood does not fall open unexpectedly.

3

✓ Omega 200

✓ Omega 250

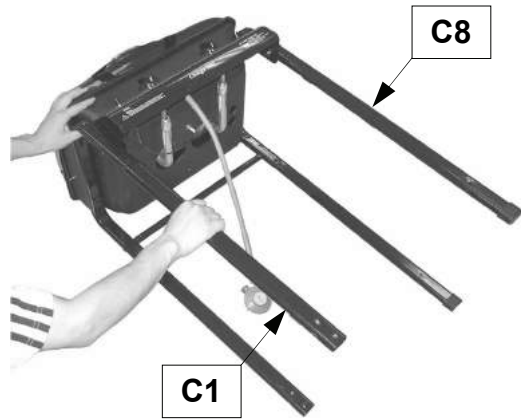

Omega 200

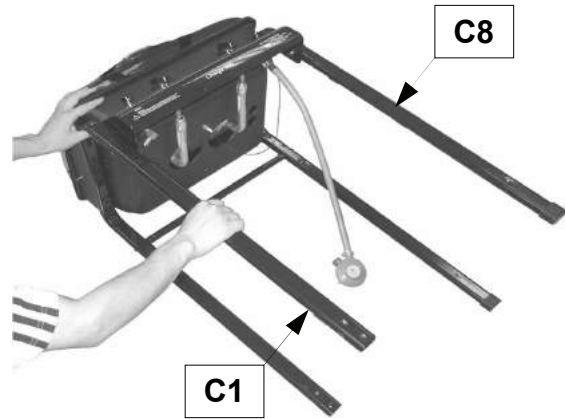

Omega 250

NOTE: Ensure that the legs with the Velcro attached to them are at the front of the barbecue, with the Velcro facing inwards.

4

✓ Omega 200

✓ Omega 250

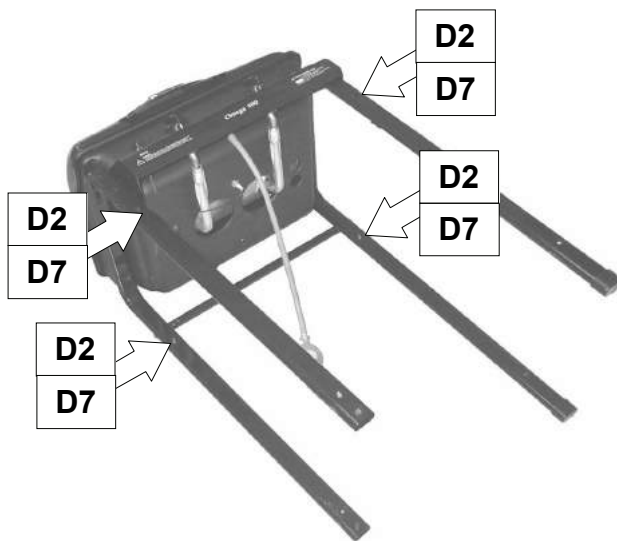

Omega 200

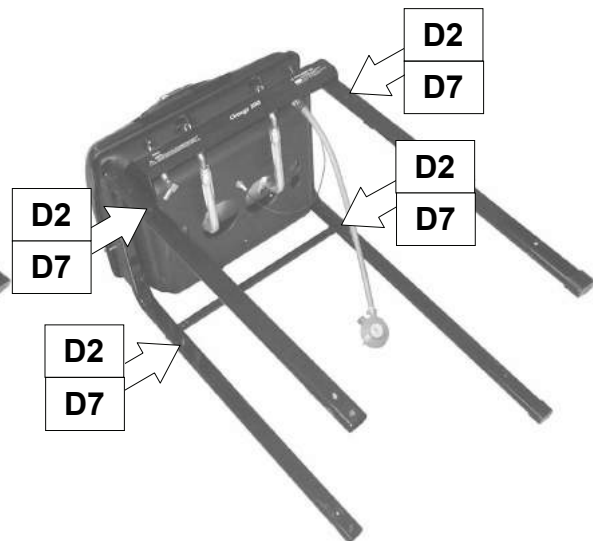

Omega 250

5

✓ Omega 200

✓ Omega 250

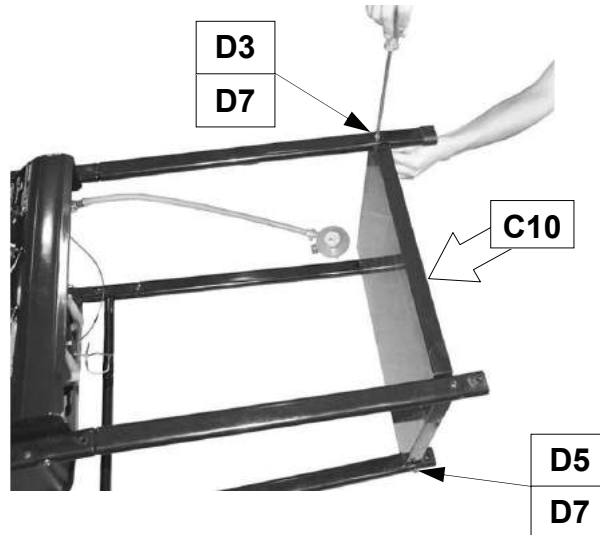

6

✓ Omega 200

✓ Omega 250

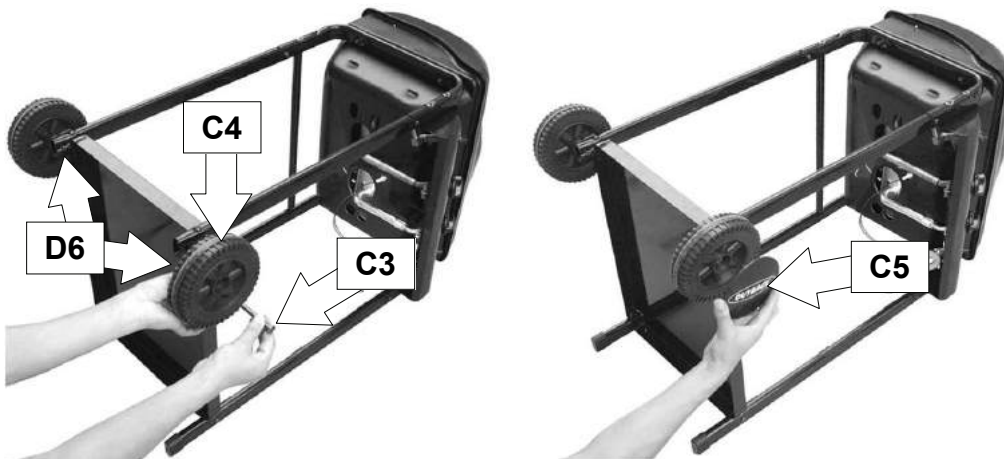

7

✓ Omega 200

✓ Omega 250

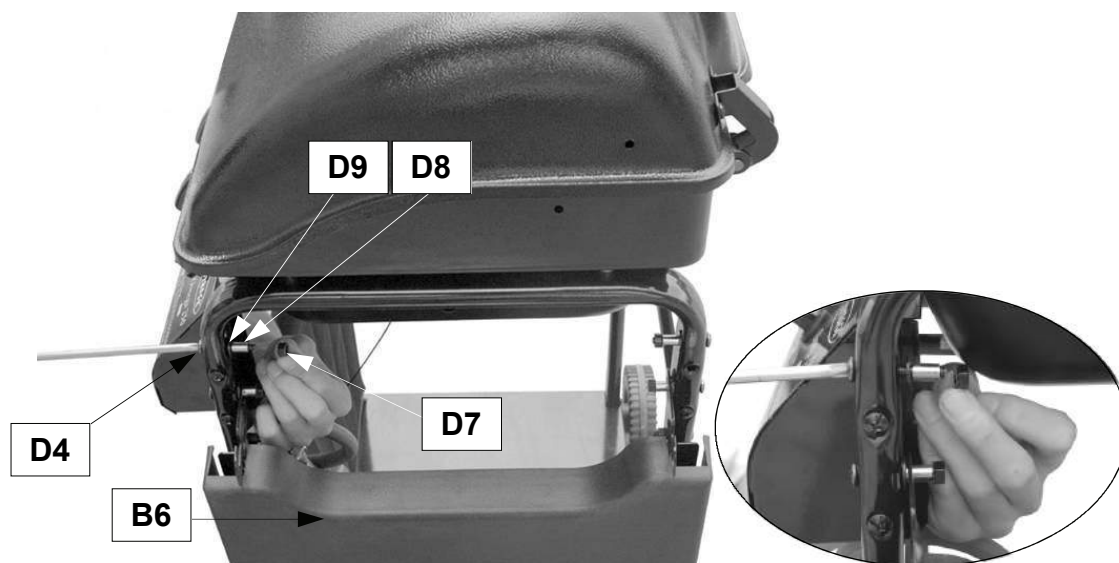

Note: The spacers and side shelf brackets go on the inside of the barbecue frame.
Omega 200: Repeat above process for the other Plastic Side Shelf (B6).

8

✗ Omega 200

✓ Omega 250

▲ Omega 200 users skip this step and proceed directly to Step 11.

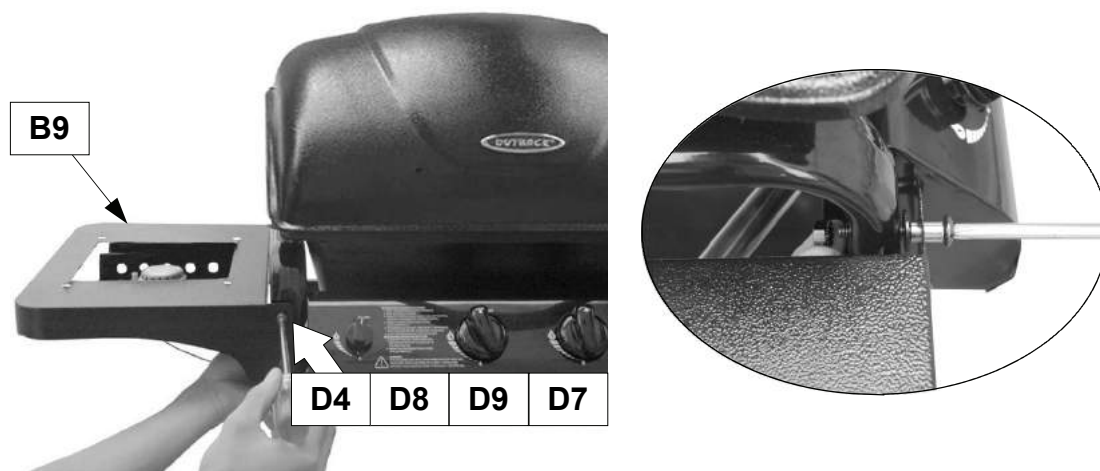

▲ Fit the side burner venturi tube over the gas valve outlet. This is a loose fit and not a gas tight seal. Then attach side burner shelf as shown in the diagram.

9

✘ Omega 200

✔ Omega 250

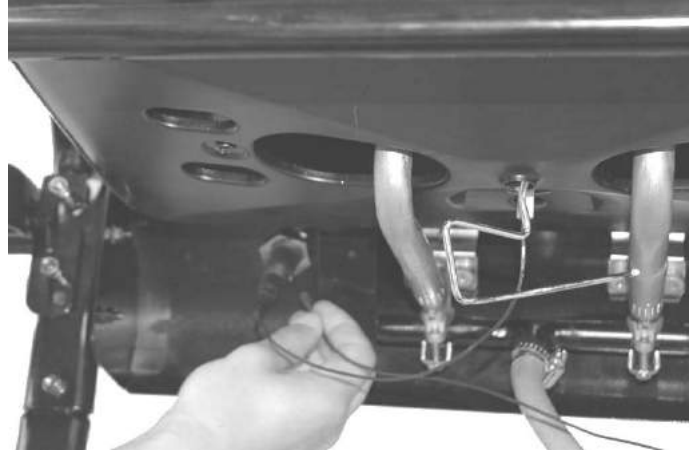

▲ Connect the side burner electrode wire to the tag on the side of the push button igniter.

10

✘ Omega 200

✔ Omega 250

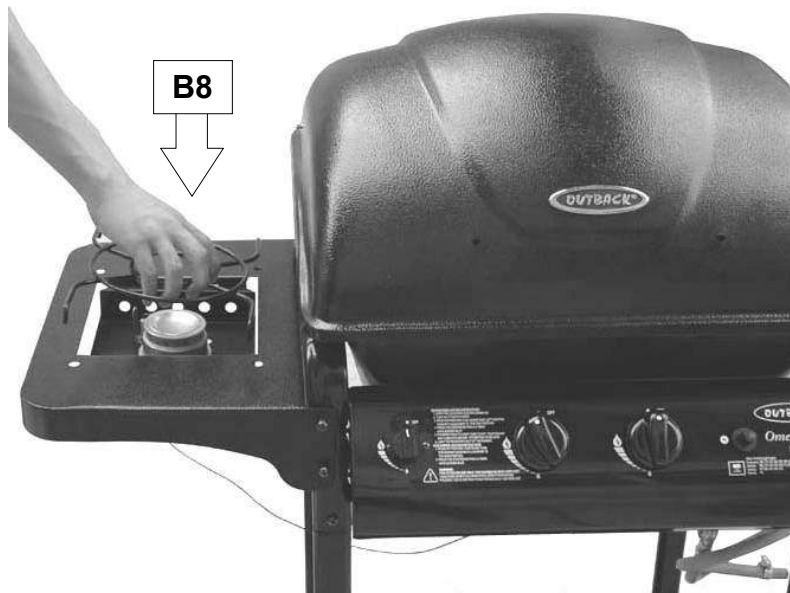

NOTE: Make sure the base of cooking utensil to put on the side burner is larger than 150mm and smaller than 220mm.

11

✓ Omega 200

✓ Omega 250

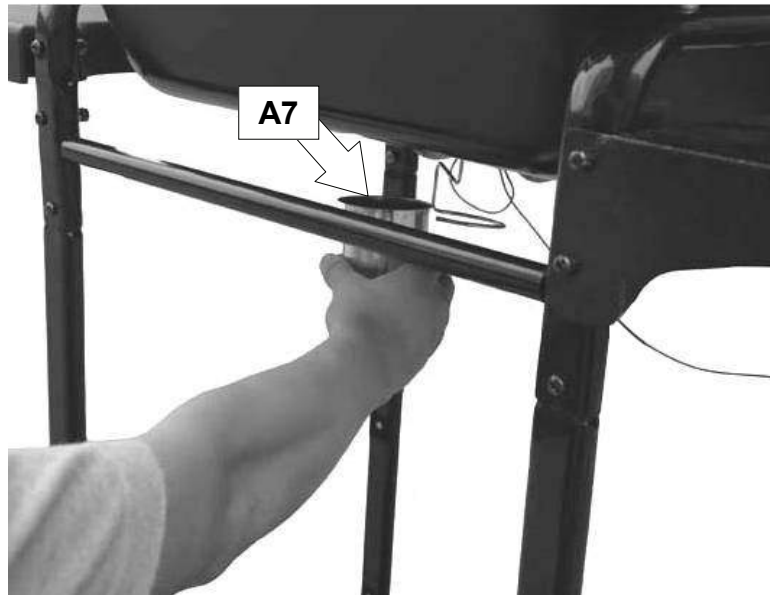

▲ Insert grease cup into wire cup holder.

12

✓ Omega 200

✓ Omega 250

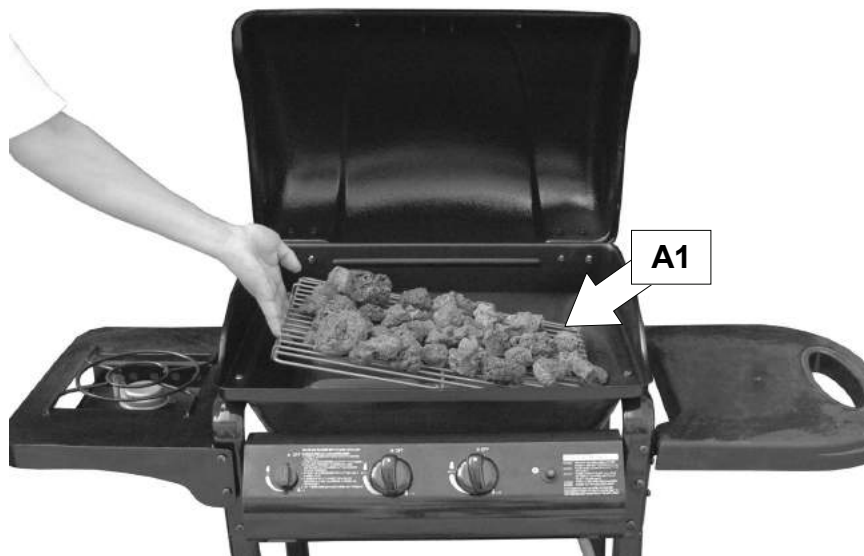

13

✓ Omega 200

✓ Omega 250

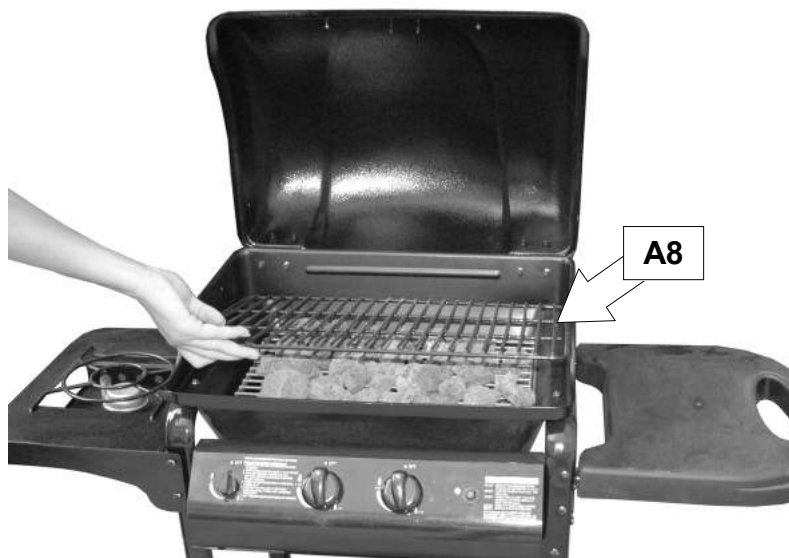

14

✓ Omega 200

✓ Omega 250

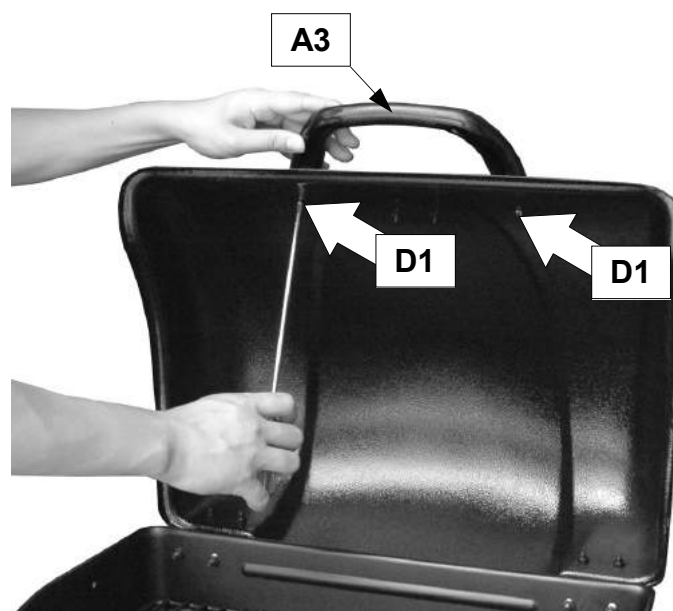

15

✓ Omega 200

✓ Omega 250

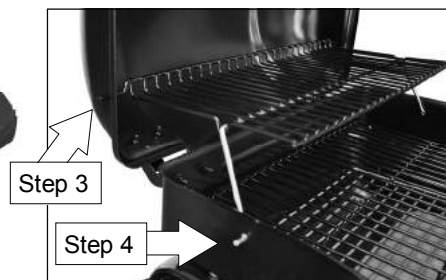

16

✓ Omega 200

✓ Omega 250





1. Maximum diameter or breadth is 315mm.
2. Maximum height (regulator included) is 580mm.

**ASSEMBLY IS NOW COMPLETE.
PROCEED TO THE NEXT PAGE FOR INSTRUCTIONS ON OPERATION AND
MAINTENANCE**

ALL JOINTS AND CONNECTIONS MUST NOW BE **LEAK TESTED** BEFORE USING THE
BARBECUE.

Leak test annually, and whenever the gas bottle is removed or replaced.

Leak Testing

Always perform a leak test in a well-ventilated area.

Step 1 - Confirm all control knobs are in the off position.

Step 2 - Turn the gas on / open the gas control valve on the gas bottle or regulator.

Step 3 - Check for leaks by brushing a solution of $\frac{1}{2}$ water and $\frac{1}{2}$ liquid detergent / soap over all the gas system joints, including gas bottle valve connections, hose connections, and regulator connections.

Step 4 - NEVER USE AN OPEN FLAME to test for leaks at any time.

Step 5 - If bubbles form over any of the joints there is a leak

- Turn off the gas supply at the gas bottle
- Retighten all joints
- Repeat test
- If bubbles form again do not use the barbecue and contact your local distributor for assistance.

Always wipe the mixed solution ($\frac{1}{2}$ water and $\frac{1}{2}$ liquid detergent / soap) from all joints and connections after leak testing.

E. Important Information

Please read these instructions carefully before assembly and use of your barbecue.

- ▲ Retain these instructions for future reference.
- ▲ This product is for outdoor use only. Do not use indoors.
- ▲ Do not use the barbecue or store gas bottles below ground level. LP gas is heavier than air so if a leak occurs the gas will collect at a low level and could ignite in the presence of a flame or spark.
- ▲ For use with LPG bottled gas only. A suitable regulator must be used for butane, propane or mixes.
- ▲ Remove plastic wrap from any part before lighting.
- ▲ Do not use within 1m of any flammable structure or surface. Do not use under any combustible surface.
- ▲ LP gas bottles should never be placed directly underneath the barbecue.
- ▲ LP gas bottles should never be stored or used laid on their side, in the horizontal position. A leak would be very serious and liquid could enter the gas line with serious result.
- ▲ Never store gas bottles indoors.
- ▲ Open the barbecue hood before lighting.
- ▲ Once lit, do not move the barbecue until it has completely cooled, after use.
- ▲ This barbecue must not be left unattended when lit.
- ▲ The hood or lid handle can become very hot. Grip only the centre of the handle. Always use oven gloves when cooking or carrying out any adjustments to the barbecue.
- ▲ Use purpose designed barbecue tools with long, heat resistant handles.
- ▲ Use Caution when opening hood or lid, as hot steam inside is released upon opening.
- ▲ Parts of this barbecue become very hot – care must be taken, especially when children, elderly people, and animals are present.
- ▲ Turn off the gas supply at the gas bottle after use.
- ▲ Never cover a barbecue until it has completely cooled.
- ▲ Use this barbecue only on a stable, flat surface.
- ▲ Before you use your barbecue, perform a

leak test. This is the only safe and sure way to detect any gas leaking from joints and connections of the barbecue after assembly.

- ▲ Leak test annually, and whenever the gas bottle is removed or replaced.
- ▲ Do not store flammable materials near this barbecue.
- ▲ Do not use aerosols near this barbecue.
- ▲ Failure to follow the manual's instructions could result in serious injury or damage.
- ▲ Parts sealed by the manufacturer or his agent must not be altered by the user.
- ▲ Modification of the barbecue may be dangerous, is not permitted and will nullify any warranty.
- ▲ If you have any queries regarding these instructions, contact your local dealer.

F. Gas, Regulator and Hose

This barbecue can use either propane or butane or propane-butane mixed LPG (liquid petroleum gas) bottled gas. Propane bottles will supply gas all year round, even on cold winter days. Butane bottles will supply sufficient gas in summer, but it may affect the performance of the barbecue and restrict the heat output available from the burners, particularly once the gas temperature starts to fall below +10°C. A spanner may be required to change gas bottles.

- The hose should hang freely with no bends, twisting, tension, folds, or kinks that could obstruct free flow of gas. Always inspect the hose for cuts, cracks, or excessive wear before use.
- Apart from the connection point, no part of the hose should touch any hot barbecue parts. If the hose shows any sign of damage it must be replaced with a hose suitable for use with LP gas which meets the national standards for the country of use.
- A suitable hose must comply with EN16436-1 or local regulation, and the length should not exceed 1.5 metres.

For optimal performance, we suggest to use a 13kg gas bottle. A suitable regulator must comply with EN16129. YOU MUST HAVE THE PROPER REGULATOR AND BOTTLE IN ORDER FOR THE BARBECUE TO OPERATE SAFELY AND EFFICIENTLY. USE OF AN INCORRECT OR FAULTY REGULATOR IS DANGEROUS AND WILL INVALIDATE ANY

WARRANTY. Please consult your local gas dealer for the most suitable gas bottles and regulators.

G. Installation

Selecting a Location

This barbecue is for **outdoor use only** and should be placed in a well-ventilated area, and on a safe and even surface. Never place your barbecue below ground level. Take care to ensure that it is not placed **UNDER** any combustible surface. The sides of the barbecue should **NEVER** be closer than 1 metre from any combustible surface, including trees and fences and make sure that there are no heat sources near the barbecue (cigarettes, open flames, spark etc.). Keep this barbecue away from any flammable materials!

Precautions

Do not obstruct any ventilation openings in the barbecue body.

Position the gas bottle on level ground next to the barbecue and safely away from any source of heat.

Should you need to install or change the gas bottle, confirm that the barbecue is switched off, and that there are no sources of ignition (cigarettes, open flame, sparks, etc.) near before proceeding.

Connecting a Gas Hose to the Barbecue

Connect the gas hose to the gas rail inlet on the left hand side of the barbecue. Do not overtighten. Do not use any sealing tape, paste or liquid on the connection.

Fixing a Regulator to the Gas Bottle

Confirm all barbecue control knobs are in the off position. Connect the regulator to the gas bottle according to your regulator and bottle dealer's instructions.

H. Operation

Warnings

- ▲ Before proceeding, make certain that you understand the **IMPORTANT INFORMATION** section of this manual.
- ▲ Your barbecue is not designed to be used with more than 50% of the cooking area as a solid plate — this includes baking dishes. Full coverage will cause excessive build-up

of heat and damage the barbecue. This is not covered by warranty.

Preparation Before Cooking

To prevent foods from sticking to the cooking surface, please use a long handled brush to **apply a light coat of cooking or vegetable oil before each barbecuing session.** (Note: When cooking for the first time, paint colours may change slightly as a result. This is normal and should be expected.) During use, the protective coating may come off the cooking surface. This is normal and is not harmful.

Lighting the Barbecue

- Open the barbecue hood or lid before lighting. **Never** light your barbecue with the hood or lid closed.
- Ensure all knobs are in the off position. Open the gas control valve on the gas bottle or regulator.
- Push and turn the leftmost control knob to the high position. Press the ignition button rapidly several times until left portion of the burner is lit.
- If burner fails to ignite after following above procedure, turn all the knobs to the off position. Close the gas valve on the gas bottle. Wait 5 minutes. Reattempt all of the above steps. If the barbecue still fails to light, please refer to the manual ignition instructions below.
- After successful lighting of the left side, turn the rightmost control knob to the high position. The remaining portion of the burner should ignite automatically.
- After ignition, turn the burners to the low position for 3-5 minutes in order to pre-heat the barbecue. This should be done before each cooking session. The hood or lid must be open during preheating.
- Keep the burner controls on the low position for best cooking results.

Manual Ignition Instructions

- Open the barbecue hood or lid before lighting. **Never** light your barbecue with the hood or lid closed.
- Ensure all knobs are in the off position. Open the gas control valve on the gas bottle or regulator.
- Insert lit match through the right match-lighting hole on the underside of the barbecue body and place near rightmost burner porthole.
- Push and turn the rightmost control knob anti-clockwise to the high position, taking

care to protect yourself from the flames.

- After the right portion of the burner is lit, light the remaining portion of the burner.
- If burner fails to ignite, contact your local dealer for assistance.
- After ignition, turn the burners to the low position for 3-5 minutes in order to pre-heat the barbecue. This should be done before each cooking session. The hood or lid must be open during preheating.
- Keep the burner controls on the low position for best cooking results.

Lighting the Side Burner (if applicable)

Push and turn the side burner control knob anti-clockwise to the high position. Push the ignition button rapidly until the side burner ignites. If the side burner fails to ignite, turn the control knob to the OFF position and wait five minutes before attempting to re-light following the above procedure. If the side burner still fails to ignite, turn the control knob off, wait five minutes and light with match.

When using the side-burner, care should be taken to ensure that pans are central and flat on the side-burner grid.

Grill Cooking

The burners heat up the lava rock underneath the grill, which in turn heats the food on the grill. The natural food juices produced during cooking fall onto the lava rock below and vaporise. The subsequent rising smoke bastes the food, as it travels upwards, imparting that unique barbecued flavour.

Do not roast food with the hood closed. Closing the hood for prolonged periods of time can lead to overheating of the barbecue or fat fires, which will damage the barbecue.

Warming Rack

Warming racks are a convenient way to keep cooked food warm or to warm items such as bread rolls. It is advisable to place food (particularly fatty foods) to the front of the warming rack to avoid the possibility of juices and fat running down the back of your barbecue. Always check that your warming rack is properly fitted before use.

Flare-Up Control *Very Important Notice*

Flare-ups occur when meat is barbecued, and its fat and juices fall upon the hot lava rock. Smoke of course helps give food its barbecued

flavour, but it is best to avoid excessive flare-up to prevent food being burned. **To control flare-ups, it is ABSOLUTELY ESSENTIAL to trim away excess fat from meat and poultry before grilling, use cooking sauces and marinades sparingly and try to avoid very cheap cuts of meat or meat products as these tend to have a high fat and water content. Also, the burners should always be placed on the low setting during cooking.**

When flare-ups do occur, they can usually be extinguished by applying baking soda or salt directly onto the lava rock. Always protect your hands when handling anything near the cooking surface of the barbecue and take care to protect yourself from the flames.

If a fat fire occurs, please see the instructions given below.

Fat Fires

Empty and clean the grease cup of food debris after each cooking session. If the barbecue is to be used for large gatherings, it will be necessary to turn off and cool the barbecue every two hours to remove food debris from the grease cup, and clean it out. The time between cleaning may need to be reduced if very fatty foods or cheap meat products are being cooked. Failure to do this may result in a fat fire, which may cause injury and could seriously damage the barbecue.

In the event of a fat fire:

- If safe to do so, turn all control knobs to the 'off' position.
- Turn off the gas supply at the gas bottle.
- Keep everyone at a safe distance from the barbecue and wait until the fire has burnt out.
- Do not close the hood or lid of the barbecue.
- NEVER DOUSE A BARBECUE WITH WATER. IF AN EXTINGUISHER IS USED, IT SHOULD BE A POWDER TYPE.
- DO NOT REMOVE THE GREASE CUP.
- If the fire does not seem to be abating or appears to be worsening, contact your local Fire Brigade for assistance.

End of Cooking Session

After each cooking session, keep the barbecue burners on the "low" position and burn for 5 minutes. This procedure will burn off cooking residue, thus making cleaning easier. Make sure the hood or lid is open during this process.

Turning Off Your Barbecue

When you have finished using your barbecue, turn all the control valves fully clockwise to the "Off" position, then switch off the gas supply at the bottle.

Wait until the barbecue is sufficiently cool before closing its hood or Lid.

I. Care and Maintenance

Regularly clean your barbecue between uses and especially after extended periods of storage. Ensure the barbecue and its components are sufficiently cool before cleaning. Do not leave the barbecue exposed to outside weather conditions or stored in damp, moist areas.

- ▲ Never handle hot parts with unprotected hands.
- ▲ Never douse the barbecue with water when its surfaces are hot.

In order to extend the life and maintain the condition of your barbecue, we strongly recommend that the unit be covered when left outside for any length of time, especially during the winter months. Heavy-duty barbecue covers and other accessories are available from your local stockist.

Even when your barbecue is covered for its protection, it must be inspected on a regular basis as damp or condensation can form which may result in damage to the barbecue. It may be necessary to dry the barbecue and the inside of the cover. It is possible for mould to grow on any fat remaining on parts of the barbecue. This should be cleaned off smooth surfaces with hot soapy water.

Any rust that is found that does not come into contact with the food should be treated with a rust inhibitor and painted with barbecue paint or a heat resistant paint.

Cooking Surfaces & Warming Rack

When the barbecue has cooled, clean with hot soapy water. To remove any food residue, use a mild cream cleaner on a non-abrasive pad. Do not use scouring pads or powders as they can permanently damage the finish. Rinse well and dry thoroughly. Due to the weight of the cooking surfaces, we do not recommend cleaning in a dishwasher.

Burner

Your burner has been preset for optimal flame performance. You will normally see a blue flame, possibly with a small yellow tip when the burner is alight. If the flame pattern is significantly yellow, this could be a problem caused by grease from cooking blocking the burner, or debris or insects in the burner portholes or venturi tubes. This can result in the flow of the gas and air mixture being restricted or blocked which may result in a fire behind the control panel causing serious damage to your barbecue. **If this happens, and if safe to do so, the gas should be immediately turned off at the bottle.**

Burner should be inspected, removed and cleaned on a regular basis, at least annually, in addition to the following conditions:

- 1) Bringing the barbecue out of storage.
- 2) One or more of the burners do not ignite.
- 3) The burner flame pattern is significantly yellow.
- 4) The gas ignites behind the control panel.
- 5) When heavy build up is found.

Provided that they are operating correctly, in normal usage, burning off the residue after cooking will keep the burners clean.

To clean a burner fully, remove it from the barbecue. A soft wire brush can be used to remove corrosion from the burner surfaces. Use a pipe cleaner or piece of wire to clear obstructions in the burner portholes and venturi tubes, taking care not to enlarge the portholes.

Clean the insect screen on the end of the venturi tube with a bristle brush (i.e. an old toothbrush).

You may need a torch to see into the venturi tube to make sure it is clear. Turn the burner up on end and lightly tap against a hard surface like a piece of wood, to dislodge any debris from inside.

When refitting the burner, be careful to check that the venturi tubes of the burner fit over the valve outlets.

Lava Rock

It is not necessary to remove and wash the lava rock in order to keep it clean. With the hood opened burning off the residue for 3 to 5 minutes after each cooking session should be sufficient. Heavily impregnated lava rock should

be turned over so that the dirty side faces the burners in order to burn off any residue. Replacement lava rock is available from your local stockist.

Grease Cup

After every use, empty and clean the grease cup of any fat or food particles, using a plastic or wooden scraper if necessary.

Failure to keep it clean, and excessive build up can result in a fat fire. This can be hazardous and severely damage the barbecue. **This is not a fault in the barbecue and is therefore not covered by the terms of the warranty.** If required, the cup can be washed in hot soapy water.

Barbecue Body

Regularly remove excess grease or fat from the barbecue body using a cloth wrung out in hot soapy water and dry thoroughly. Excess fat and food debris can be removed from inside the body using a soft plastic or wooden scraper. It is not necessary to remove all the grease from the body. If you need to clean fully, use hot soapy water and a cloth, or nylon-bristled brush only. Do not use abrasives. Remove cooking surfaces and burners before full cleaning. Do not immerse the gas controls or manifold in water. Check burner operation after carefully refitting into body.

Barbecue Hood or Lid & Trolley

Use a non-abrasive cloth or pad and clean with hot, soapy water. Do not use scouring pads or powders as they can permanently damage the finish.

Fixings

All screws and bolts, etc. should be checked and tightened on a regular basis.

Storage

Ensure the barbecue is properly cooled before covering or storing. Store your barbecue in a cool dry place.

Cover the burners with aluminium foil in order to prevent insects or other debris from collecting in burner holes.

If the barbecue is to be stored indoors, the gas bottle must be disconnected and left outside. The gas bottle should always be stored outside, in a dry, well-ventilated area, away from any sources of heat or ignition. Do not let children

tamper with the bottle.

When using the barbecue after extended periods of storage follow the cleaning procedures.

J. Technical Specifications

NOTES:

	CE Approval	Heat Input	Burners	Injector Size	Gas /Pressure
Outback® Omega 200 Gas	0359 359BL239	6.6 kW	1	0.89mm	Butane: 28-30 mbar Propane: 37 mbar
Outback® Omega 250 Gas	0359 359BL239	6.6 kW	1	0.89mm	Butane: 28-30 mbar Propane: 37 mbar
Side Burner	0359 359BL239	2.3 kW	1	0.74mm	Butane: 28-30 mbar Propane: 37 mbar

Gas Consumption:

Omega 200: 480g/hr
Omega 250: 480g/hr
Side Burner: 167g/hr

Countries of Use:

I₃₊ (28-30/37) BE, CH, CY, CZ, ES, FR, GB, GR, IE, IT, LT, LU, LV, PT, SK, SI

Specifications are subject to change without prior notice.

Troubleshooting

Problem	Possible Cause	Solution
Burner will not light using the ignition system	LP gas bottle is empty	Replace with full bottle
	Faulty regulator	Have regulator checked or replaced
	Obstructions in burner	Clean burner
	Obstructions in gas jets or gas hose	Clean jets and gas hose
	Electrode or ignition button wire is loose or disconnected on electrode or ignition unit	Reconnect wire
	Electrode or wire is damaged	Change electrode and wire
	Faulty ignition button	Change ignitor and / or button
Burner will not light with a match	LP gas bottle is empty	Replace with full bottle
	Faulty regulator	Have regulator checked or replaced
	Obstructions in burner	Clean burner
	Obstructions in gas jets or gas hose	Clean jets and gas hose
Low flame or flashback (fire in burner tube— a hissing or roaring noise may be heard)	LP gas bottle too small	Use larger bottle
	Obstructions in burner	Clean burner
	Obstructions in gas jets or gas hose	Clean jets and gas hose
	Windy conditions	Use barbecue in a more sheltered position
Gas valve knob difficult to turn	Gas valve jammed	Replace gas valve

Manufacturer:
 TPA Industrial (DG) Co. Ltd.
 Xingguang Rd., Huangjiang, Dongguan
 Guangdong, China 523768

OUTBACK® WARRANTY

OUTBACK® barbecues are warranted to the original purchaser against defects in materials and workmanship. OUTBACK® will supply replacements for defective parts free of charge provided that:

- ◆ The product has not been used for trade, professional or hire purposes.
- ◆ The product has not been subjected to misuse or neglect, including fat fires and flare ups or use of a faulty or incorrect regulator.
- ◆ The product has not sustained damage through foreign objects, substances or accidents.
- ◆ The care and maintenance instructions given in your OUTBACK® manual have been followed.

Any warranty and guarantee claims shall be rendered void in the event of improper use of the barbecue or the use of non-approved fuels. Discolouration, rusting or slight deformation of parts exposed directly to the flames (grill, griddle, flame tamer, burner, etc.) do not impair the function of the barbecue and do not form a basis for any claims.

This warranty is offered as an extra benefit and is in addition to the customers' statutory rights.

OUTBACK® does not in any way warranty the gas cylinder.

In the unlikely event that you experience problems with this barbecue, please fill in our warranty form at:

<http://www.outbackbarbecues.com/warranty-form>

One of our colleagues will be in contact with you shortly.

For reference and correspondence, record your serial number here.
(See sticker on side of barbecue body.)

Serial No. _____

This number may be required when ordering spare parts or accessories. A part reference number may also be required where applicable.

HELPLINE NUMBER: 0345 388 6032



Distribuidor oficial para España:

The Barbecue Store

Avda. Carmen Saenz de Tejada, 1

29650 Mijas Costa (Málaga)

Teléfono: 952477152 - 952477161

Fax.: 952580781

Email: dmblico2@telefonica.net

<http://www.thebarbecuestore.es>